

PRODUCTS

	Products	Page
	Metro Max Q	10-15
	Shelving kits	11
	Shelves, components & accessories	12-15
	Other Products	
	Bow-tie dunnage racks	19
	Dish dollies	18
	Drying racks	19
	Ice Cart	18
	Security carts	19
	Polymer Utility Carts	
	Deep ledge utility carts	16
	Flat style utility carts	16
	Metro lodgix - Housekeeping carts	17
	Mini bar restocking cart	17
	Smart Wall G3 systems	20-22
	Smart wall accessories	21, 22
	Super Erecta Metroseal 3	2-7
	Shelving kits	3
	Shelves, components & accessories	4-7
	Super Erecta Pro	8, 9
	Shelving kits and shelves	9
	Top Track Compactus Style Shelving	23
	T-Series Food Transport Carts	24

SUPER ERECTA METROSEAL 3 - WIRE SHELVING

Best value shelving with 12 year warranty

12 year warranty against corrosion

Easy assembly

Extra thick epoxy finish on posts and shelves

Robust construction

275 KG
PER SHELF

Microban[®]
antibacterial protection
Inhibits the growth of stain and odour causing bacteria

- Epoxy coated steel wire shelving system with Microban[®] anti-bacterial coating
- 12 year warranty against corrosion
- Easy assembly and adjustment, no tools required
- Extra thick epoxy coating in Metro green
- Designed to hold 275kg per shelf (evenly distributed)

SUPER ERECTA METROSEAL 3 SHELVING KITS - MULTI TIER

3 TIER - Metroseal 3 wire shelving with extra thick epoxy coating - includes 3 shelves, 4 x 1895mm high posts and shelf support clips

Length	355 wide		455 wide		535 wide		610 wide	
	Code	RRP (ex gst)	Code	RRP (ex gst)	Code	RRP (ex gst)	Code	RRP (ex gst)
760	3T74.1430.NK3	\$161	3T74.1830.NK3	\$169			3T74.2430.NK3	\$180
915	3T74.1436.NK3	\$165	3T74.1836.NK3	\$175	3T74.2136.NK3	\$190	3T74.2436.NK3	\$198
1065	3T74.1442.NK3	\$177	3T74.1842.NK3	\$185	3T74.2142.NK3	\$204	3T74.2442.NK3	\$215
1220	3T74.1448.NK3	\$185	3T74.1848.NK3	\$196	3T74.2148.NK3	\$212	3T74.2448.NK3	\$225
1370			3T74.1854.NK3	\$207	3T74.2154.NK3	\$228	3T74.2454.NK3	\$242
1525	3T74.1460.NK3	\$204	3T74.1860.NK3	\$217	3T74.2160.NK3	\$239	3T74.2460.NK3	\$252
1830	3T74.1472.NK3	\$223	3T74.1872.NK3	\$247	3T74.2172.NK3	\$266	3T74.2472.NK3	\$282

4 TIER - Metroseal 3 wire shelving with extra thick epoxy coating - includes 4 shelves, 4 x 1895mm high posts and shelf support clips

Length	355 wide		455 wide		535 wide		610 wide	
	Code	RRP (ex gst)	Code	RRP (ex gst)	Code	RRP (ex gst)	Code	RRP (ex gst)
760	4T74.1430.NK3	\$191	4T74.1830.NK3	\$202			4T74.2430.NK3	\$216
915	4T74.1436.NK3	\$195	4T74.1836.NK3	\$209	4T74.2136.NK3	\$231	4T74.2436.NK3	\$242
1065	4T74.1442.NK3	\$213	4T74.1842.NK3	\$224	4T74.2142.NK3	\$249	4T74.2442.NK3	\$263
1220	4T74.1448.NK3	\$224	4T74.1848.NK3	\$238	4T74.2148.NK3	\$260	4T74.2448.NK3	\$278
1370			4T74.1854.NK3	\$252	4T74.2154.NK3	\$281	4T74.2454.NK3	\$299
1525	4T74.1460.NK3	\$249	4T74.1860.NK3	\$267	4T74.2160.NK3	\$296	4T74.2460.NK3	\$314
1830	4T74.1472.NK3	\$274	4T74.1872.NK3	\$306	4T74.2172.NK3	\$332	4T74.2472.NK3	\$353

5 TIER - Metroseal 3 wire shelving with extra thick epoxy coating - includes 5 shelves, 4 x 1895mm high posts and shelf support clips

Length	355 wide		455 wide		535 wide		610 wide	
	Code	RRP (ex gst)	Code	RRP (ex gst)	Code	RRP (ex gst)	Code	RRP (ex gst)
760	5T74.1430.NK3	\$222	5T74.1830.NK3	\$235			5T74.2430.NK3	\$253
915	5T74.1436.NK3	\$229	5T74.1836.NK3	\$241	5T74.2136.NK3	\$271	5T74.2436.NK3	\$285
1065	5T74.1442.NK3	\$249	5T74.1842.NK3	\$262	5T74.2142.NK3	\$294	5T74.2442.NK3	\$312
1220	5T74.1448.NK3	\$262	5T74.1848.NK3	\$280	5T74.2148.NK3	\$307	5T74.2448.NK3	\$330
1370			5T74.1854.NK3	\$298	5T74.2154.NK3	\$334	5T74.2454.NK3	\$357
1525	5T74.1460.NK3	\$294	5T74.1860.NK3	\$316	5T74.2160.NK3	\$352	5T74.2460.NK3	\$375
1830	5T74.1472.NK3	\$325	5T74.1872.NK3	\$366	5T74.2172.NK3	\$397	5T74.2472.NK3	\$424

For single shelves please see over
For Super Erecta accessories, please see pages 5-7M







SUPER ERECTA METROSEAL 3 SINGLE SHELVES

Metroseal 3 wire single shelves with extra thick epoxy coating - includes shelf support clips

Length	355 wide		455 wide		535 wide		610 wide	
	Code	RRP (ex gst)	Code	RRP (ex gst)	Code	RRP (ex gst)	Code	RRP (ex gst)
760	S.1430.NK3	\$34	S.1830.NK3	\$37			S.2430.NK3	\$41
915	S.1436.NK3	\$36	S.1836.NK3	\$39	S.2136.NK3	\$45	S.2436.NK3	\$48
1065	S.1442.NK3	\$40	S.1842.NK3	\$43	S.2142.NK3	\$50	S.2442.NK3	\$54
1220	S.1448.NK3	\$43	S.1848.NK3	\$47	S.2148.NK3	\$53	S.2448.NK3	\$58
1370			S.1854.NK3	\$51	S.2154.NK3	\$59	S.2454.NK3	\$64
1525	S.1460.NK3	\$50	S.1860.NK3	\$55	S.2160.NK3	\$63	S.2460.NK3	\$68
1830	S.1472.NK3	\$57	S.1872.NK3	\$66	S.2172.NK3	\$73	S.2472.NK3	\$79





For Super Erecta accessories, please see pages 5-7M

SUPER ERECTA METROSEAL 3 ACCESSORIES





Description	Model	Overall Unit Size (mm) WxDxH	RRP ex GST
<p>Castors</p> <p>127mm diameter castors to fit Super Erecta posts for full mobility</p> <p>General purpose Resilient Wheel Tread swivel castor Resilient Wheel Tread brake castor</p> <p>High grease and oil resistance Polyurethane Wheel Tread swivel castor Polyurethane Wheel Tread brake castor</p>  5M  5MB	<p>ME.5M ME.5MB ME.5MP ME.5MPB</p>		<p>\$31 \$36 \$48 \$54</p>
<p>Donut Bumpers</p> <p>For use over legs to protect mobile units</p> 	<p>ME.9992N</p>		<p>\$14</p>
<p>"S" Clip*</p> <p>Use to open up corners for increased storage on Super Erecta shelving 2 required per shelf. (Sold as a pair, zinc plated finish only)</p> 	<p>ME.9995Z</p>		<p>\$16</p>
<p>Post clamp</p> <p>Clamp neighbouring shelving assemblies together for extra rigidity. (Zinc plated finish only)</p> 	<p>ME.9994Z</p>		<p>\$9</p>

*Accessory not compatible with the Super Erecta Pro range

SUPER ERECTA METROSEAL 3 ACCESSORIES

Description	Model	Overall Unit Size (mm) WxDxH	RRP ex GST
Posts			
 <p>Post with levelling bolt foot - for standard installation</p>	ME.54PK3	1385mm	\$14
 <p>Post without bolt foot - to suit castors</p>	ME.74PK3	1895mm	\$19
Shelf supports			
 <p>Pack of 4 shelf supports used to hold shelves in place</p>	ME.9985		\$9
Glides			
 <p>Smooth polymer cover fits under leveling bolt to protect floors</p>	ME.9991P		\$5

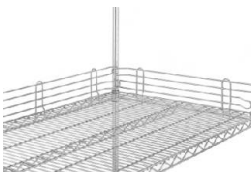
SUPER ERECTA METROSEAL 3 ACCESSORIES

Description	Model	Overall Unit Size (mm) WxDxH	RRP ex GST
<p>Slanted Label Holders*</p>  <p>Label holders for holding product labels</p>	ME.9990SL1	330mm length	\$8
<p>Clear Label Holders*</p>  <p>Clear Label Holders</p>	ME.9990CL1	330mm length	\$8
<p>Shelf Ledges - Side & back*</p>  <p>Prevents items from falling or protruding from shelves. 100mm high. Particularly useful for mobile units</p>	ME.L14N.4K3 ME.L18N.4K3 ME.L21N.4K3 ME.L24N.4K3 ME.L30N.4K3 ME.L36N.4K3 ME.L42N.4K3 ME.L48N.4K3 ME.L54N.4K3 ME.L60N.4K3 ME.L72N.4K3	355mm length 457mm length 530mm length 610mm length 760mm length 914mm length 1066mm length 1219mm length 1370mm length 1524mm length 1828mm length	\$8 \$8 \$9 \$10 \$12 \$14 \$16 \$16 \$19 \$20 \$22
<p>Shelf Dividers*</p>  <p>Keeps products and cartons in place 203mm high</p>	ME.DD14K3 ME.DD18K3 ME.DD21K3 ME.DD24K3	355mm length 457mm length 530mm length 610mm length	\$9 \$11 \$12 \$15
*Accessory not compatible with the Super Erecta Pro range			

SUPER ERECTA PRO - POLYMER MAT STYLE SHELVING

Superior mat shelving with lifetime mat warranty

12 year warranty against frame corrosion



Easy assembly

Extra thick epoxy finish on posts and frame

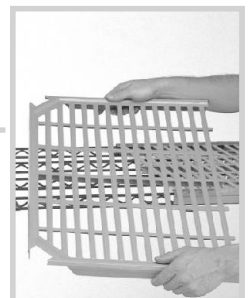

Robust polymer construction

Lifetime warranty against corrosion on mats

275
PER SHELF KG

Microban[®]
antibacterial protection
Inhibits the growth of stain and odour causing bacteria

- Epoxy coated steel wire shelving system with Microban[®] anti-bacterial coating
- Mats include Microban[®] anti-bacterial protection and are removable for easy cleaning in dishwasher
- Lifetime warranty against corrosion on mats
- 12 year warranty against corrosion on posts and frame
- Easy assembly and adjustment, no tools required
- Extra thick epoxy coating in Metro green
- Designed to hold 275kg per shelf (evenly distributed)

SUPER ERECTA PRO SHELVING KITS & SINGLE SHELVES

3 TIER - Super Erecta Pro - Removable polymer mat shelving - includes 3 shelves, 4 x 1895mm high posts and shelf support clips

Length	455 wide		610 wide	
	Code	RRP (ex gst)	Code	RRP (ex gst)
760	PR.3T74.1830.NK3	\$242	PR.3T74.2430.NK3	\$277
915	PR.3T74.1836.NK3	\$247	PR.3T74.2436.NK3	\$281
1065	PR.3T74.1842.NK3	\$277	PR.3T74.2442.NK3	\$325
1220	PR.3T74.1848.NK3	\$288	PR.3T74.2448.NK3	\$336
1525	PR.3T74.1860.NK3	\$328	PR.3T74.2460.NK3	\$379
1830	PR.3T74.1872.NK3	\$350	PR.3T74.2472.NK3	\$423

4 TIER - Super Erecta Pro - Removable polymer mat shelving - includes 4 shelves, 4 x 1895mm high posts and shelf support clips

Length	455 wide		610 wide	
	Code	RRP (ex gst)	Code	RRP (ex gst)
760	PR.4T74.1830.NK3	\$299	PR.4T74.2430.NK3	\$346
915	PR.4T74.1836.NK3	\$305	PR.4T74.2436.NK3	\$351
1065	PR.4T74.1842.NK3	\$346	PR.4T74.2442.NK3	\$411
1220	PR.4T74.1848.NK3	\$360	PR.4T74.2448.NK3	\$425
1525	PR.4T74.1860.NK3	\$414	PR.4T74.2460.NK3	\$483
1830	PR.4T74.1872.NK3	\$443	PR.4T74.2472.NK3	\$540

5 TIER - Super Erecta Pro - Removable polymer mat shelving - includes 5 shelves, 4 x 1895mm high posts and shelf support clips

Length	455 wide		610 wide	
	Code	RRP (ex gst)	Code	RRP (ex gst)
760	PR.5T74.1830.NK3	\$357	PR.5T74.2430.NK3	\$415
915	PR.5T74.1836.NK3	\$361	PR.5T74.2436.NK3	\$421
1065	PR.5T74.1842.NK3	\$415	PR.5T74.2442.NK3	\$496
1220	PR.5T74.1848.NK3	\$433	PR.5T74.2448.NK3	\$514
1525	PR.5T74.1860.NK3	\$501	PR.5T74.2460.NK3	\$586
1830	PR.5T74.1872.NK3	\$537	PR.5T74.2472.NK3	\$658

Super Erecta Pro single shelves with removable polymer shelf mats - includes shelf support clips

Length	455 wide		610 wide	
	Code	RRP (ex gst)	Code	RRP (ex gst)
760	PR.1830.NK3	\$64	PR.2430.NK3	\$77
915	PR.1836.NK3	\$69	PR.2436.NK3	\$81
1065	PR.1842.NK3	\$77	PR.2442.NK3	\$95
1220	PR.1848.NK3	\$81	PR.2448.NK3	\$99
1525	PR.1860.NK3	\$96	PR.2460.NK3	\$115
1830	PR.1872.NK3	\$104	PR.2472.NK3	\$131

For compatible Super Erecta Pro accessories, please see pages 5-6M

METROMAX Q - POLYMER MAT STYLE SHELVING

Exceptional value features:

15 year warranty against corrosion on posts and frames



Easy adjust

275
PER SHELF KG

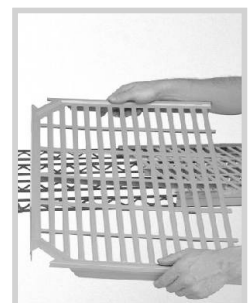

Robust polymer construction



Lifetime warranty against corrosion on mats



- Super-strong polymer mats on steel shelf frame
- 15 year warranty against corrosion on posts and frames
- Mats include Microban[®] anti-bacterial protection and are removable for easy cleaning in dishwasher
- Easy assembly and adjustment - no tools required
- Corner lock release for easy shelf adjustment
- Polymer mats have lifetime warranty against rust & corrosion
- Can be utilised with MetroMax shelving for greater warranty and strength

METROMAX Q SHELVING KITS - MULTI TIER

3 TIER - Metromax Q adjustable polymer mat shelving - includes 3 shelves, 4 x 1890mm high posts and wedge connectors

Length	455 wide		535 wide (indent only)		610 wide	
	Code	RRP (ex gst)	Code	RRP (ex gst)	Code	RRP (ex gst)
610	MAXQ.3T74.1824	\$313	MAXQ.3T74.2124	\$346		
760	MAXQ.3T74.1830	\$323	MAXQ.3T74.2130	\$354		
915	MAXQ.3T74.1836	\$329	MAXQ.3T74.2136	\$359	MAXQ.3T74.2436	\$363
1065	MAXQ.3T74.1842	\$357	MAXQ.3T74.2142	\$400	MAXQ.3T74.2442	\$405
1220	MAXQ.3T74.1848	\$367	MAXQ.3T74.2148	\$420	MAXQ.3T74.2448	\$418
1370	MAXQ.3T74.1854	\$397	MAXQ.3T74.2154	\$436	MAXQ.3T74.2454	\$451
1525	MAXQ.3T74.1860	\$410	MAXQ.3T74.2160	\$441	MAXQ.3T74.2460	\$459
1830	MAXQ.3T74.1872	\$431	MAXQ.3T74.2172	\$466	MAXQ.3T74.2472	\$502

4 TIER - Metromax Q adjustable polymer mat shelving - includes 4 shelves, 4 x 1890mm high posts and wedge connectors

Length	455 wide		535 wide (indent only)		610 wide	
	Code	RRP (ex gst)	Code	RRP (ex gst)	Code	RRP (ex gst)
610	MAXQ.4T74.1824	\$368	MAXQ.4T74.2124	\$412		
760	MAXQ.4T74.1830	\$381	MAXQ.4T74.2130	\$422		
915	MAXQ.4T74.1836	\$389	MAXQ.4T74.2136	\$429	MAXQ.4T74.2436	\$437
1065	MAXQ.4T74.1842	\$425	MAXQ.4T74.2142	\$483	MAXQ.4T74.2442	\$490
1220	MAXQ.4T74.1848	\$439	MAXQ.4T74.2148	\$510	MAXQ.4T74.2448	\$507
1370	MAXQ.4T74.1854	\$480	MAXQ.4T74.2154	\$531	MAXQ.4T74.2454	\$551
1525	MAXQ.4T74.1860	\$497	MAXQ.4T74.2160	\$539	MAXQ.4T74.2460	\$561
1830	MAXQ.4T74.1872	\$524	MAXQ.4T74.2172	\$572	MAXQ.4T74.2472	\$619

5 TIER - Metromax Q adjustable polymer mat shelving - includes 5 shelves, 4 x 1890mm high posts and wedge connectors

Length	455 wide		535 wide (indent only)		610 wide	
	Code	RRP (ex gst)	Code	RRP (ex gst)	Code	RRP (ex gst)
610	MAXQ.5T74.1824	\$422	MAXQ.5T74.2124	\$477		
760	MAXQ.5T74.1830	\$439	MAXQ.5T74.2130	\$490		
915	MAXQ.5T74.1836	\$445	MAXQ.5T74.2136	\$499	MAXQ.5T74.2436	\$508
1065	MAXQ.5T74.1842	\$494	MAXQ.5T74.2142	\$567	MAXQ.5T74.2442	\$575
1220	MAXQ.5T74.1848	\$511	MAXQ.5T74.2148	\$601	MAXQ.5T74.2448	\$596
1370	MAXQ.5T74.1854	\$562	MAXQ.5T74.2154	\$626	MAXQ.5T74.2454	\$652
1525	MAXQ.5T74.1860	\$584	MAXQ.5T74.2160	\$634	MAXQ.5T74.2460	\$664
1830	MAXQ.5T74.1872	\$618	MAXQ.5T74.2172	\$677	MAXQ.5T74.2472	\$737

For single shelves please see over
For Metromax Q accessories, please see pages 13-15M







METROMAX Q SINGLE SHELVES

Metromax Q adjustable polymer mat shelving - single shelves

Length	455 wide		535 wide (indent only)		610 wide	
	Code	RRP (ex gst)	Code	RRP (ex gst)	Code	RRP (ex gst)
610	MQ1824G	\$64	MQ2124G	\$77		
760	MQ1830G	\$68	MQ2130G	\$80		
915	MQ1836G	\$71	MQ2136G	\$89	MQ2436G	\$92
1065	MQ1842G	\$81	MQ2142G	\$98	MQ2442G	\$100
1220	MQ1848G	\$85	MQ2148G	\$106	MQ2448G	\$105
1370	MQ1854G	\$97	MQ2154G	\$112	MQ2454G	\$118
1525	MQ1860G	\$102	MQ2160G	\$118	MQ2460G	\$121
1830	MQ1872G	\$110	MQ2172G	\$124	MQ2472G	\$138



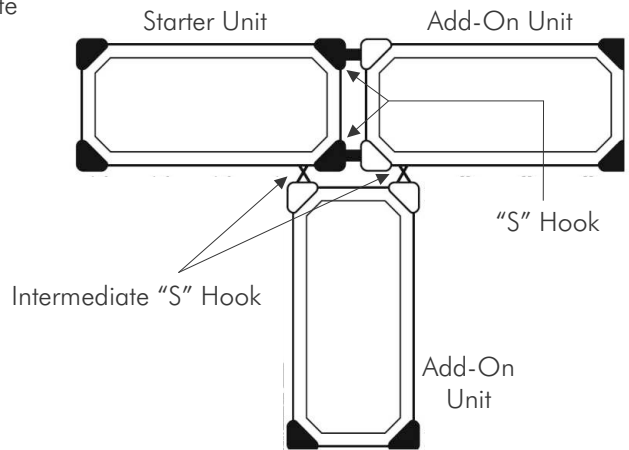

For Metromax Q accessories, please see pages 13-15M

METROMAX Q ACCESSORIES





Description	Model	Overall Unit Size (mm) WxDxH	RRP ex GST
<p>"S" Hooks</p>  <p>Eliminate the need for adjacent posts by combining MetroMax Q in a variety of configurations utilising "S" hooks. Joins units post to post. (Sold as a pair)</p>	ME.M9995		\$10
<p>Intermediate Bracket</p>  <p>Eliminate the need for extra posts by combining MetroMax Q in a variety of configurations utilising intermediate "S" hooks. Joins units post to shelf. (Sold as a pair)</p> <div data-bbox="427 1003 804 1133" style="border: 1px solid black; padding: 5px; margin-top: 10px;"> <ul style="list-style-type: none"> Regular "S" Hook location Intermediate bracket location Post Post not required </div>	ME.Q9995Z		\$12
<p>Wedge Connector</p>  <p>Supplied in bag of 4, used to hold shelves in place</p>	ME.MQ9985		\$12
<p>Stackable Side Shelf Ledges</p> <p>See below</p>	<p>ME.MQLS18.2S</p> <p>ME.MQLS21.2S</p> <p>ME.MQLS24.2S</p>	<p>457mm length</p> <p>531mm length</p> <p>610mm length</p>	<p>\$22</p> <p>\$22</p> <p>\$23</p>
<p>Stackable Back Shelf Ledges</p>  <p>Prevents items from falling or protruding from shelves - 51mm high Snap on and off quickly. Easily stacked to contain larger items. Corrosion proof</p>	<p>ME.MQL24.2S</p> <p>ME.MQL30.2S</p> <p>ME.MQL36.2S</p> <p>ME.MQL42.2S</p> <p>ME.MQL48.2S</p> <p>ME.MQL54.2S</p> <p>ME.MQL60.2S</p> <p>ME.MQL72.2S</p>	<p>610mm length</p> <p>760mm length</p> <p>914mm length</p> <p>1066mm length</p> <p>1219mm length</p> <p>1370mm length</p> <p>1524mm length</p> <p>1829mm length</p>	<p>\$23</p> <p>\$25</p> <p>\$29</p> <p>\$36</p> <p>\$36</p> <p>\$40</p> <p>\$42</p> <p>\$45</p>



METROMAX Q ACCESSORIES

Description	Model	Overall Unit Size (mm) WxDxH	RRP ex GST
Shelf Dividers			
 <p>Used to create organised compartments or to separate shelf contents. 203mm high Easily repositioned. Corrosion proof.</p>	ME.MQD18.8	457mm length	\$21
	ME.MQD24.8	610mm length	\$23
Post Clamp			
 <p>Adds stability by joining posts of two separate units together. Each unit is then supported by four posts and buttressed by the adjacent unit</p>	ME.9994X		\$19
Handles			
 <p>Provides easy manoeuverability for mobile MetroMax Q units</p>	ME.MEH18S	457mm length	\$84
	ME.MEH21S	530mm length	\$87
	ME.MEH24S	610mm length	\$89
Cutting Board & Tray Drying Racks			
 <p>Rack is mounted to standard MetroMaxQ shelf. Promotes safe air drying of cutting boards and trays. 34 drying slots - 28mm spacing 14 drying slots - 76mm spacing</p>	ME.MTR2448XE	To fit 455 x 1220 shelf only (MQ1848G)	\$117
	ME.MTR2448XEA		\$110
Label Holders			
 <p>Snap on to shelf edge to accommodate 25mm adhesive labels - Optional label holder covers available, see over page</p>	ME.Q04LH	102mm length	\$5
	ME.Q24LH	448mm length	\$12
	ME.Q30LH	600mm length	\$12
	ME.Q36LH	752mm length	\$13
	ME.Q42LH	905mm length	\$19
	ME.Q48LH	1057mm length	\$19
	ME.Q54LH	1210mm length	\$21
	ME.Q60LH	1362mm length	\$22
	ME.Q72LH	1514mm length	\$25

METROMAX Q ACCESSORIES

Description	Model	Overall Unit Size (mm) WxDxH	RRP ex GST
Label Holder Covers			
Snap on to label holder to hold non-adhesive labels in place	ME.Q04LHC	102mm length	\$5
	ME.Q24LHC	448mm length	\$8
	ME.Q30LHC	600mm length	\$8
	ME.Q36LHC	752mm length	\$8
	ME.Q42LHC	905mm length	\$11
	ME.Q48LHC	1057mm length	\$11
	ME.Q54LHC	1210mm length	\$13
	ME.Q60LHC	1362mm length	\$14
Tray Slides			
	Slides to provide high density storage. Adjust to fit steam, bun and other GN pans	ME.MQ18SE	\$115
		ME.MQ24SE	\$118
Castors			
	127mm diameter castors to fit MetroMax iQ posts to provide full mobility	ME.5MX	\$33
	General purpose	ME.5MBX	\$40
	Resilient Wheel Tread swivel castor Resilient Wheel Tread brake castor		
	High grease and oil resistance Polyurethane Wheel Tread swivel castor Polyurethane Wheel Tread brake castor	ME.5MPX	\$52
		ME.5MPBX	\$59
Posts			
	Steel post with levelling foot - for standard installation	ME.MQ54PE	\$29
		ME.MQ74PE	\$44
	Steel post to suit castors	ME.MQ63UPE	\$28

POLYMER UTILITY CARTS

Description	Model	Overall Unit Size (mm) WxDxH	Finish	RRP ex GST
-------------	-------	------------------------------	--------	------------

Deep Ledge Utility Carts



- 1 piece 70mm moulded shelf to contain product and spills
- Polymer shelves are corrosion proof and easy to clean
- Rigid chrome posts
- Easy to position centre shelf on 3 tier units, adjusts at 25mm increments
- Mounted on 100mm castors
- Available in blue as stock item, other colours available upon request
- Weight capacity of 68kg per shelf
- Can withstand temperatures up to 50°C

2 tier ledge utility cart	ME.BC2030.2D.BU	546 x 832 x 1041	Blue	\$331
3 tier ledge utility cart	ME.BC2030.3D.BU	546 x 832 x 1041	Blue	\$418
2 tier ledge utility cart	ME.BC2636.2D.BU*	685 x 984 x 1041	Blue	\$377
3 tier ledge utility cart	ME.BC2636.3D.BU*	685 x 984 x 1041	Blue	\$463

* Note: Accepts standard 500 x 500mm warewash basket

Accessories - Waste basket (including holder)	ME.BCWB2D (fits BC2030)	\$99
Accessories - Utility bin (including holder)	ME.BCUB2D (fits BC2030)	\$83

Flat Style BC Utility Carts



- 1 piece flat style shelf with 11mm recess to assist with spillage
- Polymer shelves are corrosion proof and easy to clean
- Rigid chrome posts
- Easy to position centre shelf on 3 tier units, adjusts at 25mm increments
- Mounted on 100mm castors
- Available in blue as stock item, other colours available upon request
- Weight capacity 68kg per shelf
- Can withstand temperatures up to 50°C

2 tier flat style BC utility cart	ME.BC.1627.24.MB	457 x 711 x 845	Blue	\$322
3 tier flat style BC utility cart	ME.BC.1627.34.MB	457 x 711 x 845	Blue	\$407
3 tier flat style BC utility cart	ME.BC.2030.34.MB	546 x 857 x 845	Blue	\$459
3 tier flat style BC utility cart	ME.BC.2636.34.BU	686 x 1003 x 845	Blue	\$464

Accessories - Waste basket (including holder)	ME.BCWB1 (fits BC1627) - BCWB2 (fits BC2030)	\$114
Accessories - Utility bin (including holder)	ME.BCUB1 (fits BC1627) - BCUB2 (fits BC2030)	\$83

SPECIALTY CARTS & ACCESSORIES

Description	Model	Overall Unit Size (mm) WxDxH	RRP ex GST
-------------	-------	------------------------------	------------

Mini Bar Restocking Cart



- Safely hold and transport all of your bar restocking supplies
- Advanced polymer construction: won't rust, corrode, dent, chip, flake or peel
- Thumb-activated latch/lock system secures drawers in seconds, and accepts security seal or pad lock

Mini Bar Restocking Cart	ME.FLMB1	863 x 559 x 1041	\$3,566
--------------------------	----------	------------------	----------------

Metro Lodgix - Housekeeping Carts



Shown with optional accessories

- Flexible, modular system designed to be upgradable in the field
- Polymer construction: will not rust, corrode, dent, flake, chip or peel
- Includes ergonomic positioned push handle
- Supplied with 8" (203mm) diameter castors
- Includes standard mid and base shelf under, split top bins and laundry bag
- Other sizes available on request

Metro Lodgix Essentials - Housekeeping cart	ME.LXHK4.ESS	1524 x 559 x 1295	\$1,468
---	--------------	-------------------	----------------

Metro Lodgix - Housekeeping Cart Accessories

All can be added to standard unit above

Under Deck Vacuum Holder	ME.LXHK.VH	\$88
Centre Compartment Adjustable Shelf	ME.LXHK.AS	\$121
Locking Top Shroud	ME.LXHK.TS	\$373
Side Storage Kit	ME.LXHK4.SSK	\$422
Side Storage Shelf	ME.LXHK.SS	\$67
Locking Door for Side Storage	ME.LXHK4.SDK	\$173
Waste Can	ME.LXHK.WCAN	\$185
Waste Can Holder	ME.LXHK4.WCH	\$67
Vinyl-Coated Nylon Laundry Bag	ME.LXHK4.NB	\$103
76mm Large Capacity Tote (6 per carton)	ME.TB92035NAT.LX	\$31
152mm Large Capacity Tote (4 per carton)	ME.TB92060NAT.LX	\$35

OTHER MOBILE POLYMER PRODUCTS

Description	Model	Overall Unit Size (mm) WxDxH	Finish	RRP ex GST
-------------	-------	------------------------------	--------	------------

Ice Cart



- Double wall ice cart with CFC free insulation to hold ice for extended periods of time
- Conforms to health requirements for food storage
- Rust and corrosion proof polymer construction
- Large fixed rear wheels and front swivel castors for easy mobility
- Sized to fit under standard counter
- 56kg bin capacity

Ice Cart	ME.IC125	572 x 718 x 851	Grey	\$1,154
----------	----------	-----------------	------	----------------

Dish Dolly - Adjustable



- Adjustable to suit dish sizes from 108mm - 298mm
- Polymer shell won't crack, peel or chip
- Built in handles
- Two handed plate retrieval system to reduce breakages
- Microban built-in protection which inhibits growth of bacteria, mould and mildew
- Compact size to fit under standard height bench
- 127mm castors for ease of mobility over all surfaces
- Vinyl dust cover included

Dish Dolly - Adjustable	ME.PCD11A	676 x 676 x 812	Grey	\$1,595
-------------------------	-----------	-----------------	------	----------------

Dish Dolly - Fixed



- Various fixed sizes to suit dish sizes from 108mm - 298mm
- Polymer shell won't crack, peel or chip
- Built in handles
- Microban built-in protection which inhibits growth of bacteria, mould and mildew
- Compact size to fit under standard height bench
- 127mm castors for ease of mobility over all surfaces
- Vinyl dust cover included

Dish Dolly - Fixed	ME.PCD5, 7, 8, 9, 11 & 12		Grey	\$1,236
--------------------	---------------------------	--	------	----------------

OTHER PRODUCTS

Description	Model	Overall Unit Size (mm) WxDxH	Finish	RRP ex GST
-------------	-------	------------------------------	--------	------------

Bow-Tie Dunnage Racks



- Ideal for heavy cartons
- Heavy duty construction gives rack strength to hold up to 683kg for 760mm and 914mm long racks, & 1365kg for 1219mm and 1524mm racks
- Rust and corrosion proof polymer material
- Racks join together easily without tools in end-to-end and back-to-back configurations with the exclusive bow-tie feature included

Dunnage Rack	ME.HP2230PD	560 x 760 x 305	Blue	\$293
Dunnage Rack	ME.HP2236PD	560 x 915 x 305	Blue	\$297
Dunnage Rack	ME.HP2248PD	560 x 1220 x 305	Blue	\$345
Dunnage Rack	ME.HP2260PD	560 x 1525 x 305	Blue	\$397

Drying Rack Unit



- For fast drying of trays, pans, lids, pots and all pot sink items
- Utilises MetroMax polymer shelving with stainless steel racks

Stationary Drying Rack Unit	ME.PR48X3	610 x 1219 x 1917	Grey	\$1,784
Mobile Drying Rack Unit	ME.PR48VX3	610 x 1219 x 1752	Grey	\$2,086

Metro Security Storage



Photo indicative only - mid shelves not included

- Provides a fixed storage security system
- Heavy-gauge open wire construction keeps contents visible at all times
- Double door access with each door opening 270°
- Supplied with top and bottom shelves only
- Intermediate shelves not included - see pg 4-M for available (455mm and 610mm sizes only)

Security Cart	ME.SEC33K3	980 x 546 x 1700	Green	\$1,719
Security Cart	ME.SEC53K3	980 x 695 x 1700	Green	\$1,764
Security Cart	ME.SEC55K3	1295 x 695 x 1700	Green	\$2,194
Security Cart	ME.SEC56K3	1590 x 695 x 1700	Green	\$2,382

SMART WALL G3 SYSTEMS

Smart Wall G3 systems - Organised and efficient wall space at work.

Take advantage of wasted wall space. Available in pre packaged kits (with accessories included)

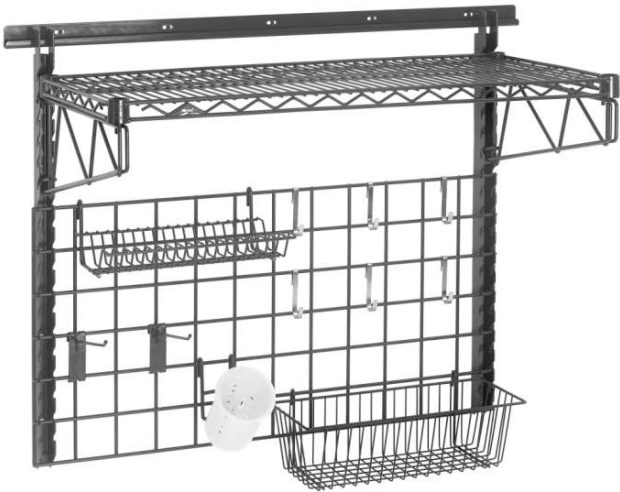

Preparation Kit (ME.STODPREP3036)
- Other accessories available
(see opposite page)

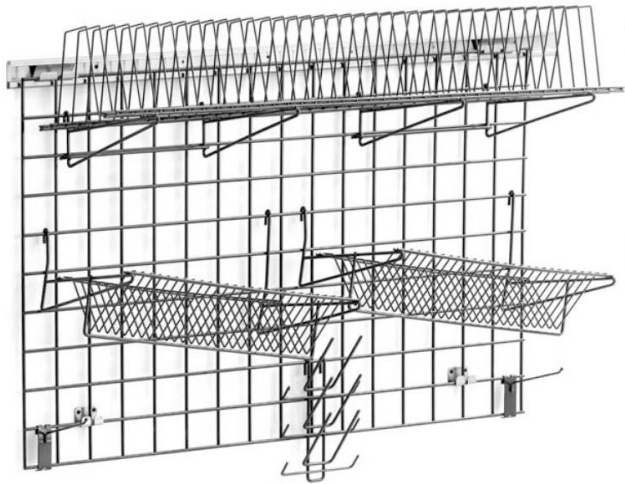

Scullery Kit (ME.STODSINK3048)
- Other accessories available
(see opposite page)

Optional Accessories

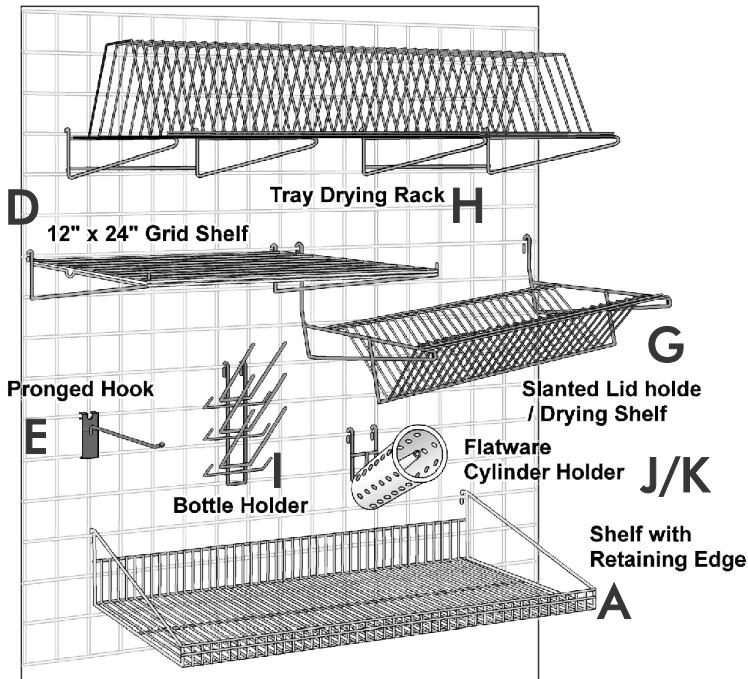
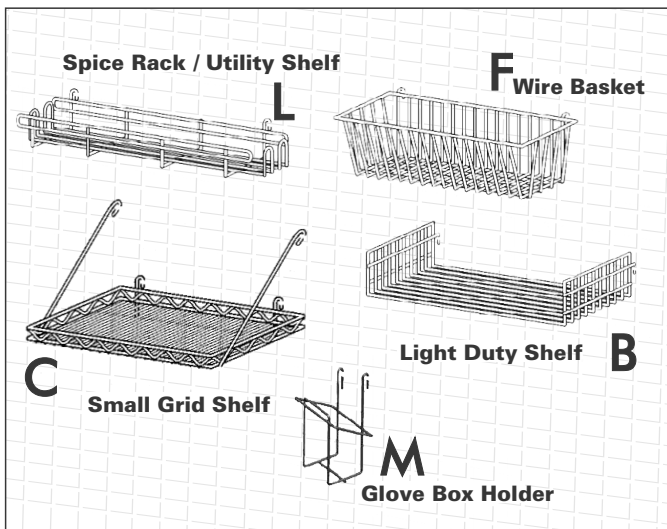

SMART WALL G3 SYSTEMS

Code	Description	Model	Overall Unit Size (mm) WxDxH	RRP ex GST
------	-------------	-------	---------------------------------	---------------

Smart Wall G3 pre-packaged kits (with accessories included)

	Scullery Kit	ME.STODSINK3048		\$994
	Preparation Kit	ME.STODPREP3036		\$905

Available customised to suit your individual requirements with the large range of accessories listed below

Smart Wall G3 systems - Accessories*

Shelves for grids

A	Shelf with retaining edge	ME.GS1436K3	391 x 895 x 197	\$173
A	Shelf with retaining edge	ME.GS1448K3	391 x 1200 x 197	\$206
A	Shelf with retaining edge	ME.GS1830K3	492 x 743 x 197	\$173
A	Shelf with retaining edge	ME.GS1836K3	492 x 895 x 197	\$190
A	Shelf with retaining edge	ME.GS1848K3	492 x 1200 x 197	\$228
B	Light duty shelf with side ledges	ME.PBA.GSDK3	470 x 228	\$92
C	Small grid shelf	ME.PBA.MSK3	425 x 425	\$94
D	Flat grid shelf	ME.FGS1224KS	322 x 610 x 102	\$155

Hooks

E	Pronged hook	ME.PGHK6K3	194 x 32 x 92	\$20
---	--------------	------------	---------------	------

Baskets

F	Small basket	ME.H209K3	127 x 345 x 180	\$53
F	Deep ledge basket	ME.H210K3	190 x 440 x 127	\$66
F	Deep ledge basket	ME.H212K3	190 x 440 x 255	\$78

Drying rack accessories

G	Slanted lid holder/Drying shelf	ME.IWA.S11K3	527 x 359 x 307	\$139
H	Tray drying rack	ME.TDR48K3	1175 x 371 x 259	\$267
I	6-Prong bottle holder	ME.BH6K3	130 x 378 x 279	\$74

Utensil holders

J	Flatware/Instrument cylinder	ME.FC1	109 x 109 x 140	\$18
K	Cylinder holder	ME.FCH	149 x 67 x 146	\$44

Miscellaneous Accessories

L	Spice rack/Utility shelf	ME.SR24K3	571 x 133 x 102	\$91
M	Glove box holder	ME.GBHVK3	162 x 267	\$43

*Available to order. Non stock items

SMART WALL G3 SYSTEMS

Description	Model	Overall Unit Size (mm) WxDxH	RRP ex GST
-------------	-------	------------------------------	------------

Smart Wall G3 systems - Accessories

Wall Tracks



ME.SW40K3	1016mm long	\$74
ME.SW56K3	1423mm long	\$81
ME.SW72K3	1828mm long	\$91

Uprights - Price per unit



ME.SWU15K3	406mm	\$79
ME.SWU30K3	787mm	\$92

Shelf supports - Price per unit*



Double model shown

Single	ME.SWS14K3	38 x 421 x 208	\$65
Single	ME.SWS18K3	38 x 522 x 208	\$68
Double	ME.SWD14K3	38 x 421 x 208	\$98
Double	ME.SWD18K3	38 x 522 x 208	\$100

Grids

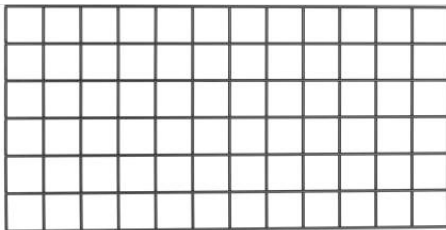

ME.WG1836K3	457 x 914	\$77
ME.WG1848K3	457 x 1219	\$96
ME.WG2436K3	610 x 914	\$133
ME.WG2448K3	610 x 1219	\$166

Grid mounting brackets required to mount grid on track and to wall

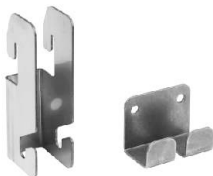

Set (1 of each)	ME.SWGB1	\$46
-----------------	----------	------

NOTE: Weight bearing capacity depends on wall fixture. For this and other information on how Metro Smart Wall can improve space and efficiency, contact your local dealer representative.

*For shelves to suit shelf supports, refer to pg 4-M

TOP TRACK COMPACTUS STYLE SHELVING



Gain up to 40% more storage capacity with the same footprint as conventional shelving

Available in Metroseal 3 and MetroMaxQ finishes

Extensive range of widths and lengths available ex stock

Top Track system for ease of cleaning and cart/trolley access

Mobile bays hold up to 410kg and movability complies with OH&S requirements

Design drawing with component list available

Simple installation with no special tools required

Extensive range of accessories available to provide total storage solutions

For costing and design service please contact your local dealer representative

TRANSPORT ARMOUR HEAVY-DUTY HEATED HOLDING CABINETS

C5 T-SERIES



Polymer armoured panels optimally located to protect the cabinet and its contents

Ducted convection heated system provides fast heat-up and recovery times

Foamed-in-place polyurethane insulation with 304 stainless steel construction for superior heat retention, better structural rigidity and minimised energy consumption

Steel reinforced polymer handles that double as bumpers to protect the cabinet

Mobile power features battery rechargeable technology to gently circulate air to hold set temperatures for longer while in transit

Available in several different sizes to suit your needs

For queries and costing please contact your local dealer representative

Laundry delivery carts as well as many other Metro value-added services are available, speak to your dealer representative for more information